



Key Features

- Modular, networked console
- Large, dual screen touchscreen interface
- Multitude of channel options
- Modular design allows for easy connection with all other models
- Ability to pre-program shows
- Protective glass cover
- Rackmount option

Description

TAIT's NAV:Centauri is a modular, networked console that can operate with other Centauri consoles or as a standalone console. It features dual touchscreens to allow users to run small systems without an external monitor and is an integrated device with an onboard server (NAV:Node) and user interface (NAV:GUI). Multiple channel options

allow users to customize inputs, creating the ideal programming and show interface for the users' system. NAV:Net removes the need for a dedicated Estop cable. Users have the ability to pre-program shows with integrated 3D previsualization allowing for offline previewing, editing and exporting of movies.

Dimensions

Front View

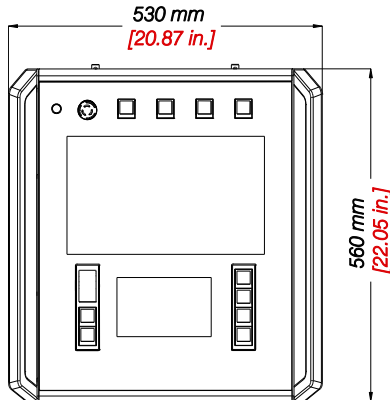

Side View

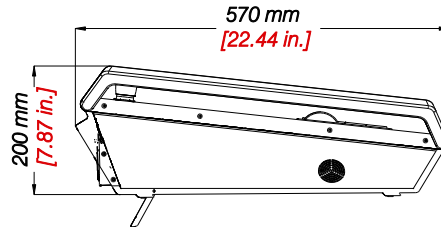

Specifications

Display	15. in touchscreen 7 in. touchscreen
Channels	See options below
Estop buttons	1
Display Macro Buttons	4
Input Power	110-240 VAC, 50/60 Hz
Enable Inputs	1
Front/Rear USB	1/2
NAV:Net Ports	2
Lamp Outputs	2
Monitor Outputs	2 HDMI

Channel Options

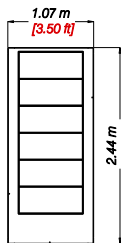

Top View

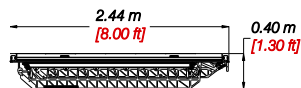

Side View (Up)

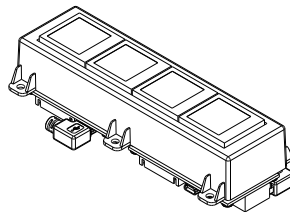

Quad Display

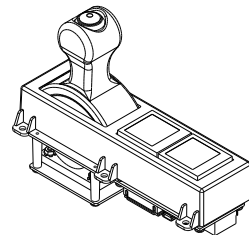

Single Axis Joystick

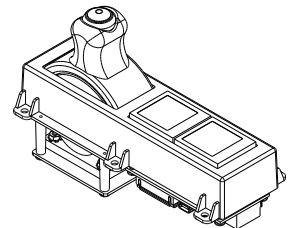

Single Axis Joystick Low Pro